

Décanteur primaire
Stockage des boues
Tampon

SBR

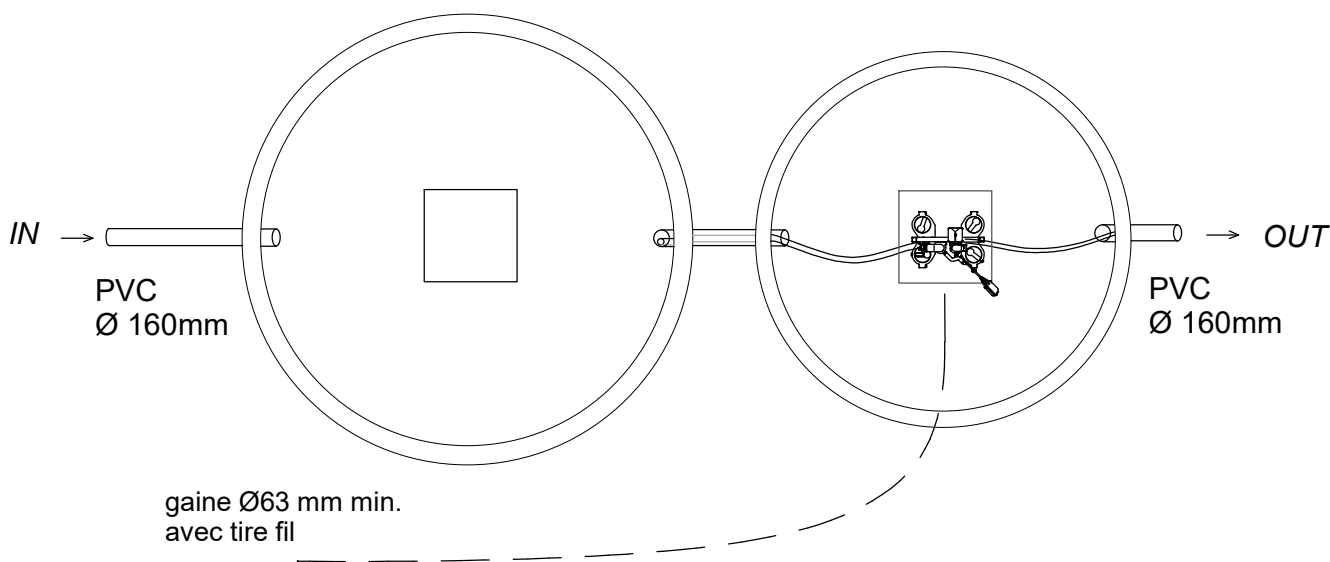

Capacité max : 35 EH
Poids décanteur : 9 850 kg
Poids SBR : 7 500 kg
Matériau: Béton
Conso elect.: 974 kWh/an
Charge hydraul.max : 4,50 m3/jour

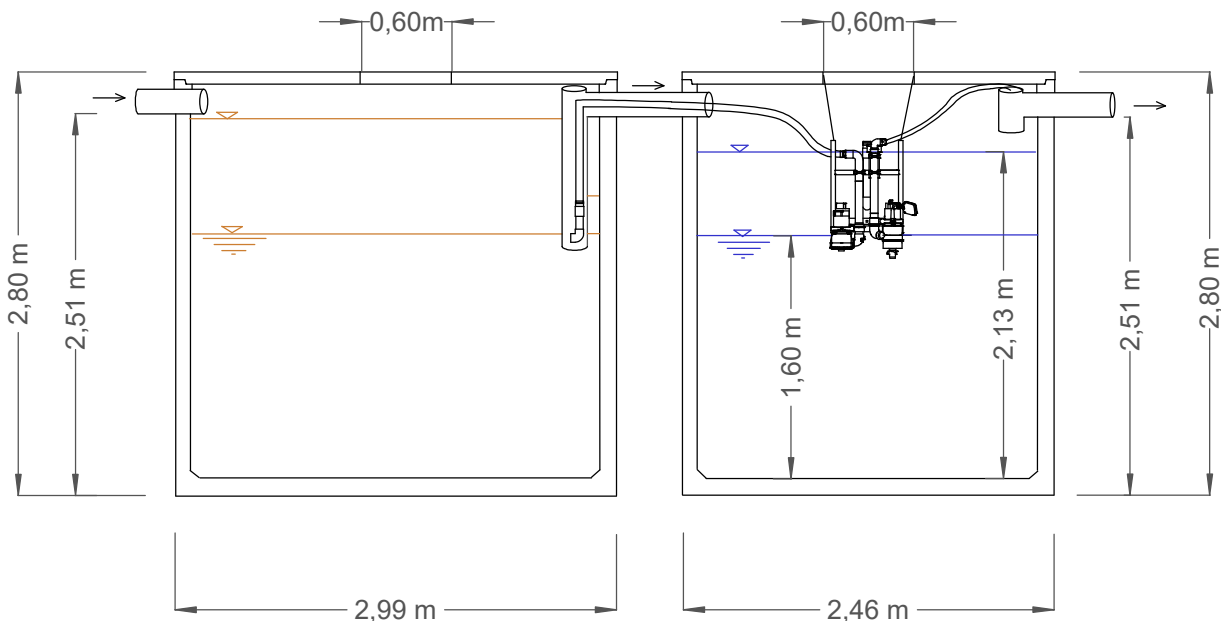

EN 12 566-3

ATB Belgique SRL

Tel : 087 37 62 71
info.belgique@atbwater.com
www.micro-station-atb.be