

AQUAmax[®] Basic - 9 EH Type P

2020/06/021/A

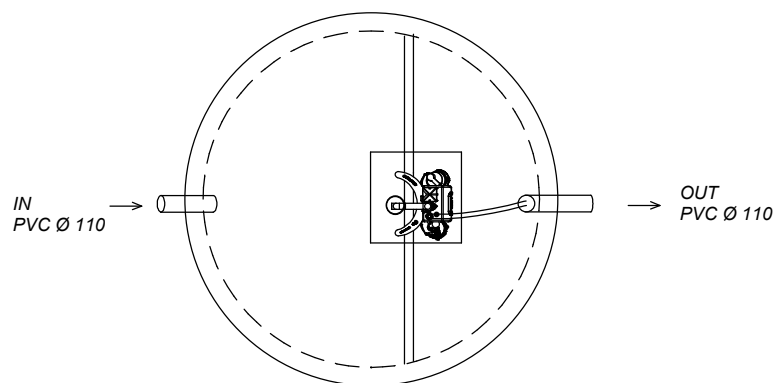

Capacité max : 09 EH
Poids cuve : 8 160kg
Matériau: Béton
Conso elect.: 320 kWh/an
Charge hydraul.max : 1,35 m3/jour

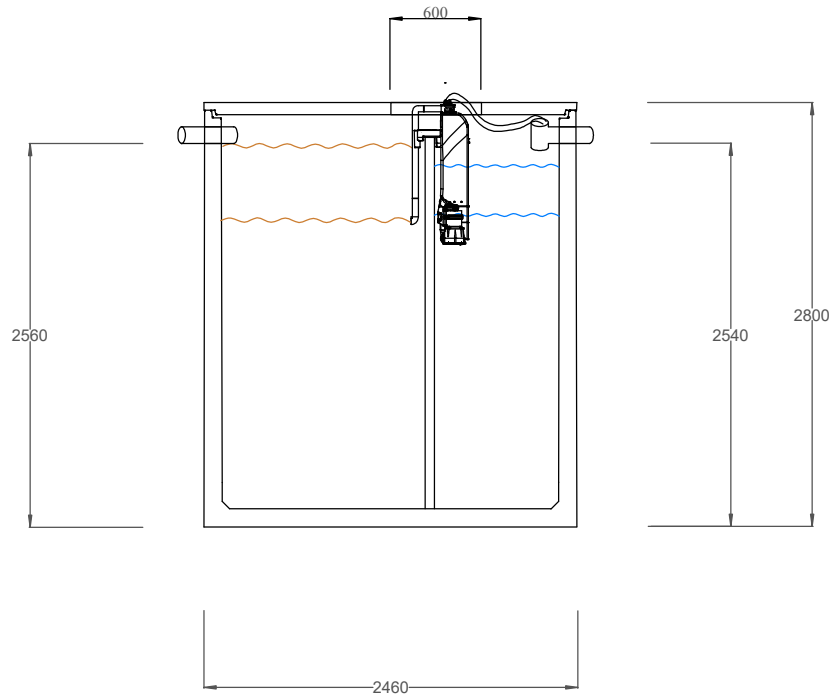

EN 12 566-3

ATB Belgique SPRL

Tel/Fax : 087 37 62 71
info@atb-belgique.be
www.micro-station-atb.be