

AQUAmax[®] Basic - 5 EH Type P

2020/06/021/A

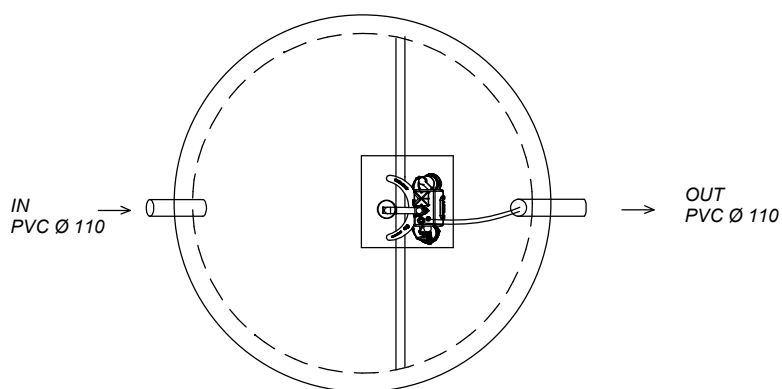

Capacité max : 05 EH
Poids cuve : 6 670kg
Matériau: Béton
Conso elect.: 180 kWh/an
Charge hydraul.max : 0,75 m3/jour

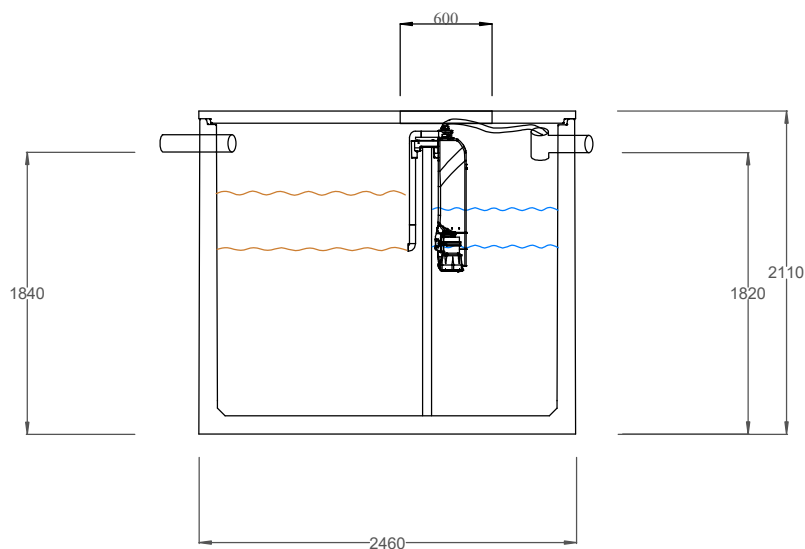

EN 12 566-3

ATB Belgique SPRL

Tel/Fax : 087 37 62 71
info@atb-belgique.be
www.micro-station-atb.be