

Décanteur primaire
Stockage des boues
Tampon

SBR

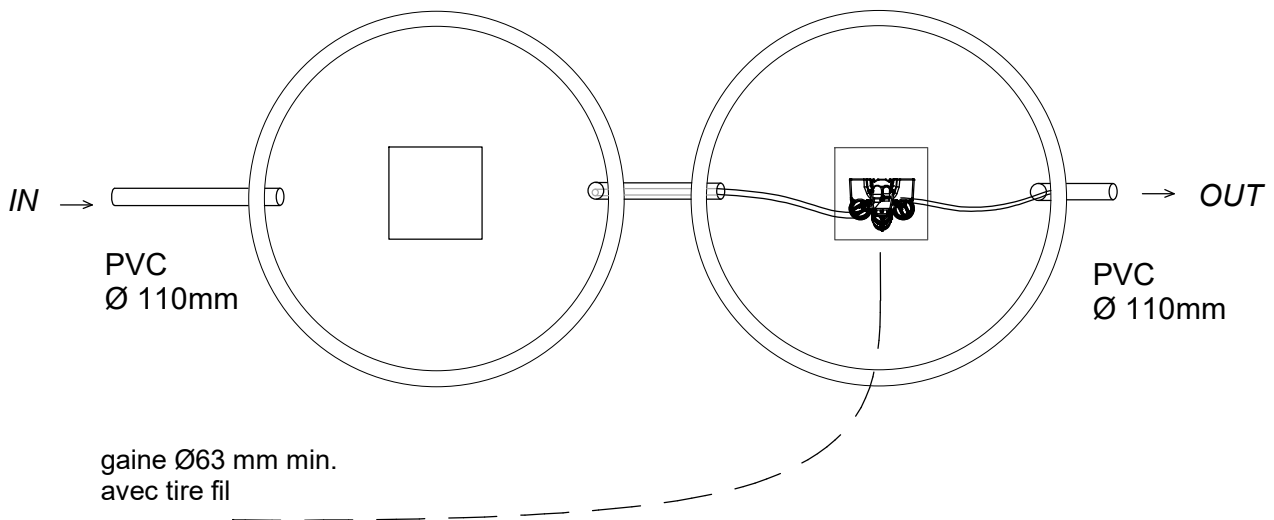

Capacité max : 16 EH
Poids décanteur : 6 200 kg
Poids SBR : 6 200 kg
Matériau: Béton
Conso elect.: 495 kWh/an
Charge hydraul.max : 2,40 m3/jour

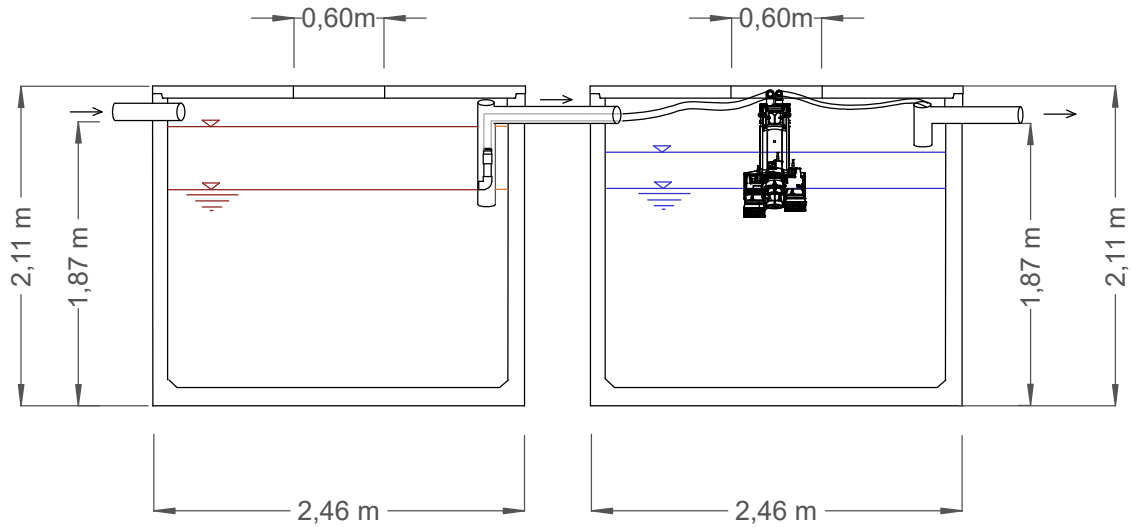

EN 12 566-3

ATB Belgique SPRL

Tel/Fax : 087 37 62 71
info@atb-belgique.be
www.micro-station-atb.be