

AQUAmax[®] Basic - 8 EH Type O

N° 2015/06/125/A

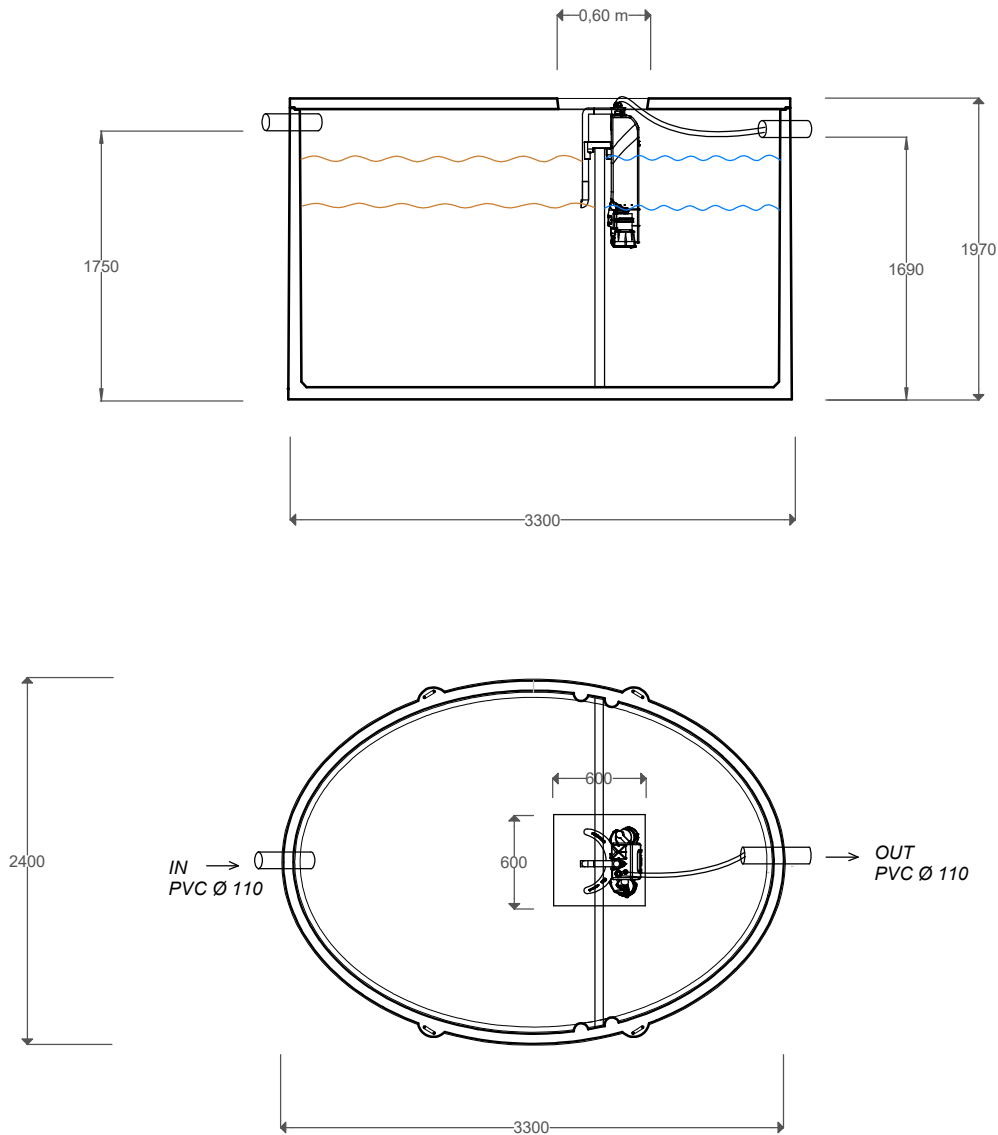

Capacité max : 08 EH
Poids cuve : 5 800kg
Matériau: Béton
Conso elect.: 386 kWh/an
Charge hydraul.max : 1,20 m3/jour



EN 12 566-3

ATB Belgique SPRL

Tel/Fax : 087 37 62 71
info@atb-belgique.be
www.micro-station-atb.be